

**FR1A  
THRU  
FR1M**

**Features**

- For Surface Mount Applications
- Extremely Low Thermal Resistance
- Easy Pick And Place
- High Temp Soldering: 250°C for 10 Seconds At Terminals
- Superfast Recovery Times For High Efficiency

**1 Amp Fast Recovery  
Silicon Rectifier  
50 to 1000 Volts**

**Maximum Ratings**

- Operating Temperature: -50°C to +150°C
- Storage Temperature: -50°C to +150°C
- Maximum Thermal Resistance; 15°C/W Junction To Lead

Microsemi Catalog Number	Device Marking	Maximum Recurrent Peak Reverse Voltage	Maximum RMS Voltage	Maximum DC Blocking Voltage
FR1A	FR1A	50V	35V	50V
FR1B	FR1B	100V	70V	100V
FR1D	FR1D	200V	140V	200V
FR1G	FR1G	400V	280V	400V
FR1J	FR1J	600V	420V	600V
FR1K	FR1K	800V	560V	800V
FR1M	FR1M	1000V	700V	1000V

**DO-214AA  
(SMBJ)**

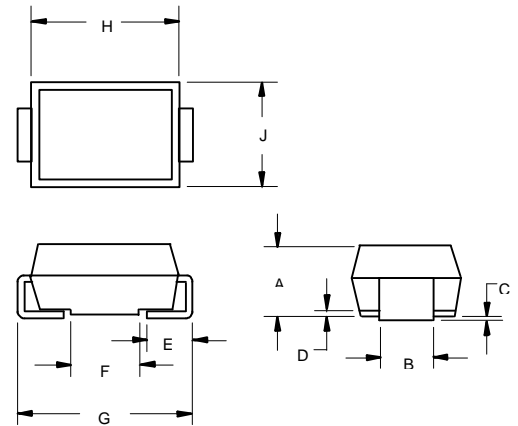

DIM	DIMENSIONS				NOTE
	INCHES		MM		
	MIN	MAX	MIN	MAX	
A	.075	.115	1.90	2.92	1
B	.081	.087	2.06	2.21	
C	.004	.008	.10	.20	
D	---	.02	---	.51	
E	.030	.060	.76	1.52	
F	.065	.084	1.65	2.13	
G	.205	.220	5.21	5.59	
H	.160	.180	4.06	4.57	
J	.130	.155	3.30	3.94	

1) Maximum Jeduc Spec is .096" or 2.44 MM

**SUGGESTED SOLDER  
PAD LAYOUT**

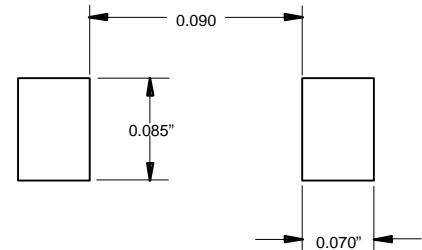

**Electrical Characteristics @ 25°C Unless Otherwise Specified**

Average Forward current	$I_{F(AV)}$	1.0A	$T_J = 90^\circ\text{C}$
Peak Forward Surge Current	$I_{FSM}$	30A	8.3ms, half sine
Maximum Instantaneous Forward Voltage	$V_F$	1.30V	$I_{FM} = 2.0A;$ $T_J = 25^\circ\text{C}^*$
Maximum DC Reverse Current At Rated DC Blocking Voltage	$I_R$	5 $\mu\text{A}$ 200 $\mu\text{A}$	$T_J = 25^\circ\text{C}$ $T_J = 125^\circ\text{C}$
Maximum Reverse Recovery Time	$T_{rr}$	150ns 250ns 500ns	$I_F=0.5A, I_R=1.0A,$ $I_{rr}=0.25A$
Typical Junction Capacitance	$C_J$	50pF	Measured at 1.0MHz, $V_R=4.0V$

\*Pulse test: Pulse width 200  $\mu\text{sec}$ , Duty cycle 2%

# FR1A thru FR1M

Figure 1  
Typical Forward Characteristics

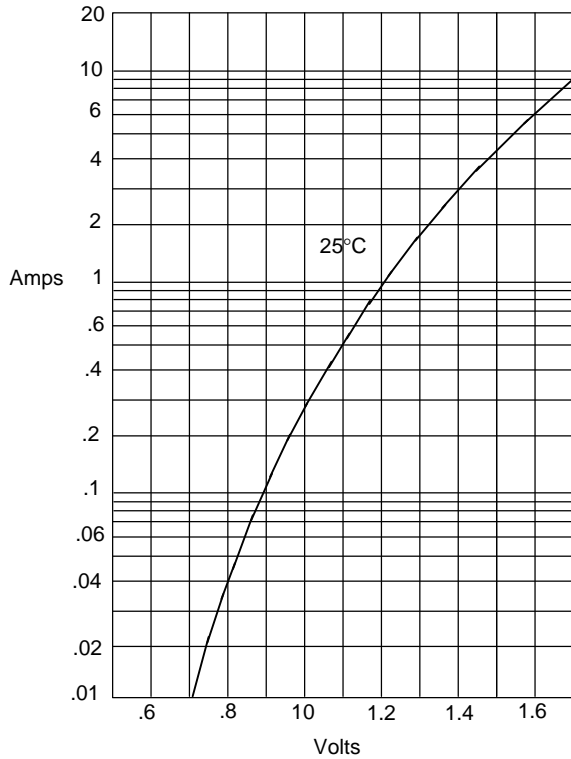

Instantaneous Forward Current - Amperes versus  
Instantaneous Forward Voltage - Volts

Figure 2  
Forward Derating Curve

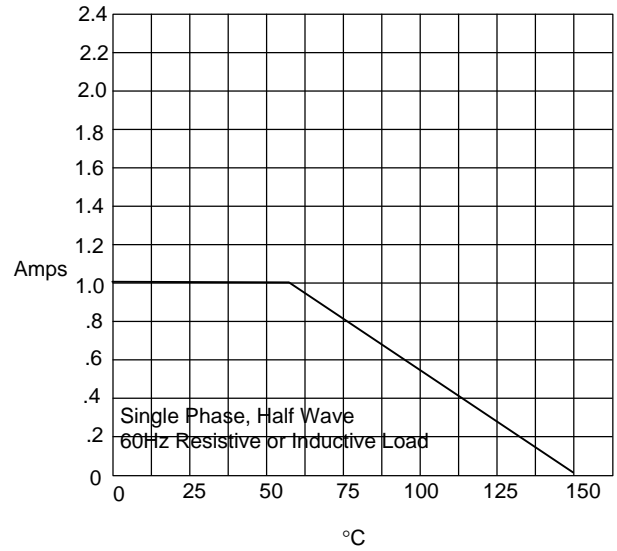

Average Forward Rectified Current - Amperes versus  
Ambient Temperature - °C

Figure 3  
Junction Capacitance

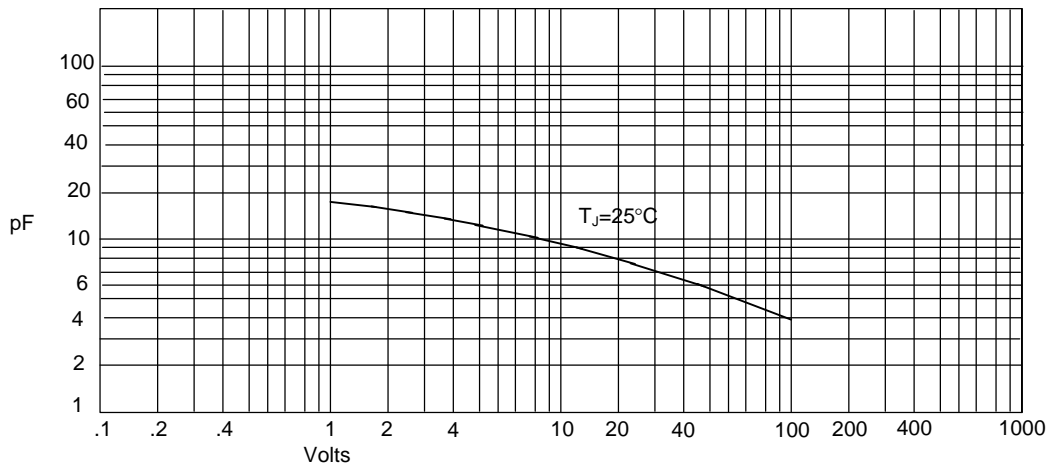

Junction Capacitance - pF versus  
Reverse Voltage - Volts

# FR1A thru FR1M

Figure 4  
Peak Forward Surge Current

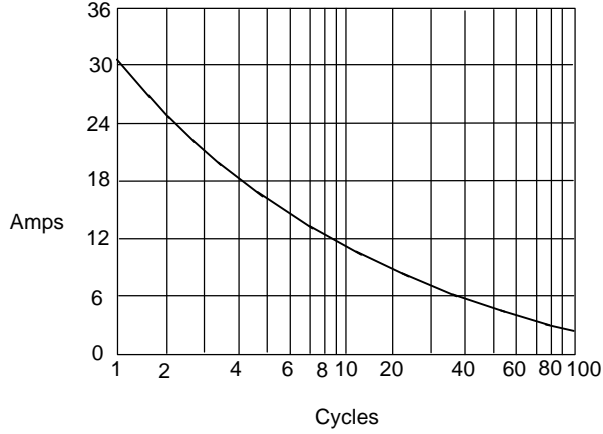

Peak Forward Surge Current - Amperes versus  
Number Of Cycles At 60Hz - Cycles

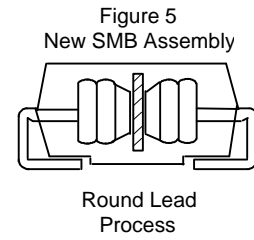
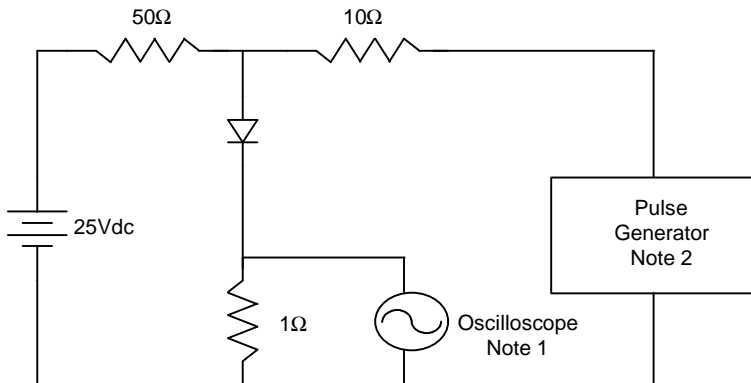

Figure 6  
Reverse Recovery Time Characteristic And Test Circuit Diagram



- Notes:
1. Rise Time = 7ns max.  
Input impedance = 1 megohm, 22pF
  2. Rise Time = 10ns max.  
Source impedance = 50 ohms
  3. Resistors are non-inductive

